

PRA-012

(Ref. 2156)

ANTENA UHF UHF ANTENNA ANTENNE UHF



Especificaciones técnicas / Technical specifications / Données techniques

Banda de frecuencias Frequency band Bande de fréquences		MHz	470 - 862
Ganancia Gain Gain		dBi	11
Impedancia Impedance Impédance		Ω	75
Relación D/A Front-to-Back ratio Rapport AV/AR		dB	≥ 25
Angulo de abertura Beamwidth Angle d'ouverture	H	°	63
	V	°	50
Carga frontal del viento Frontal windload Charge frontale au vent	150 km/h	N	190
	200 km/h	N	340
Carga lateral del viento Lateral windload Charge latérale au vent	150 km/h	N	105
	200 km/h	N	185

Fijación al mástil / Mast fixing / Fixation sur le mât

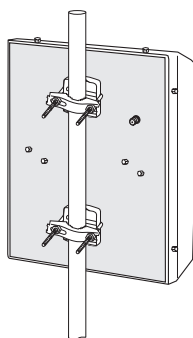
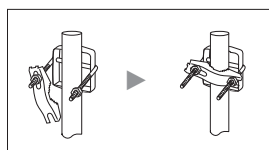

Conexión coaxial / Coaxial connection / Raccordement coaxial

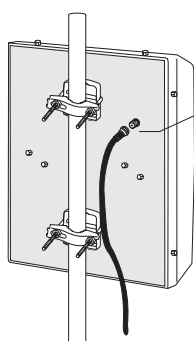

conexión tipo F
F type connection
raccordement type F

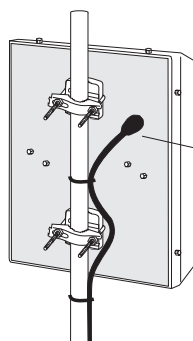

Proporcionar estanqueidad con la cinta suministrada
Provide watertightness with the tape supplied
Procurer étanchéité avec le ruban fourni

cinta auto-vulcanizable suministrada
self-vulcanizing tape supplied
ruban auto soudable fourni

30 cm

Inclinación vertical / Vertical tilt / Inclinaison verticale

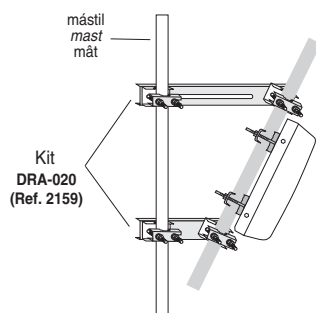

Adaptación Polarización Vertical / Vertical Polarisation Adaptation / Adaptation Polarization Verticale

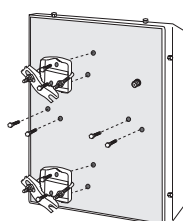

Soltar amarres y tornillos,
Loosen clamps and screws,
Desserer étriers et vis,

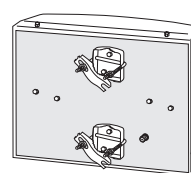

y colocarlos donde se indica.
and place them where it is indicated.
et les placer où il est indiqué.

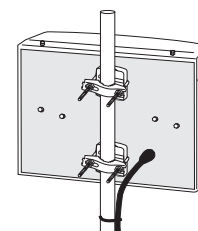

Instalar la antena.
Install the antenna.
Installer l'antenne.